

PORTER

PRODUCTS AND PARTS CATALOG

APRIL 2010



PORTER

POLICIES

- PRICES** ALL PRICES ARE F.O.B. HATFIELD, PA, AND SUBJECT TO CHANGE WITHOUT NOTICE. ALL MERCHANDISE WILL BE INVOICED AT PRICES IN EFFECT AT TIME OF SHIPMENT. PRICES DO NOT INCLUDE INSURANCE, FREIGHT, TAXES OR SPECIAL HANDLING. THESE CHARGES, IF APPLICABLE, WILL BE SHOWN SEPARATELY ON INVOICE. **MINIMUM ORDER \$60.00**
- PAYMENT TERMS** NET 30 DAYS AFTER INVOICE DATE. ALL INVOICES PAST DUE ARE SUBJECT TO A FINANCE CHARGE OF 1 1/2 % PER MONTH. (18% ANNUAL RATE).
- SHIPMENTS** SHIPMENT OF MERCHANDISE SHALL AT ALL TIMES BE SUBJECT TO CREDIT APPROVAL AND WILL BE CONTINGENT UPON FIRES, ACCIDENTS, EMERGENCIES, ACTS OF GOD OR ANY OTHER CAUSES WHICH ARE BEYOND PORTER INSTRUMENT DIVISION'S CONTROL.
- CANCELLATIONS** NO CANCELLATIONS WILL BE ACCEPTED ON NON-STANDARD OR SPECIAL MERCHANDISE, EXCEPT BY PAYMENT OF FULL PURCHASE PRICE. IF BUYER REQUESTS CANCELLATION OF ANY ORDER OR PART THEREOF, AND IS AGREED TO BY PORTER INSTRUMENT DIVISION IN WRITING, BUYER WILL BE SUBJECT TO CANCELLATION CHARGES TO COVER THE COST OF MATERIAL AND/OR FABRICATION INCURRED BY PORTER INSTRUMENT DIVISION TO DATE OF CANCELLATION.
- CHANGES OF ORDER** A MINIMUM OF 90 DAYS NOTICE IS REQUIRED ON ALL CHANGES TO ORDERS AND WILL BE SUBJECT TO RE-SCHEDULING AS A NEW ORDER AT PORTER INSTRUMENT DIVISION'S DISCRETION
- RETURNS** NO RETURNS WILL BE ACCEPTED UNLESS AUTHORIZED IN WRITING BY PORTER INSTRUMENT DIVISION, AND ACCOMPANIED BY A PROPERLY COMPLETED RETURN GOODS AUTHORIZATION. ALL RETURNS ARE SUBJECT TO A RE-STOCKING FEE AND POSSIBLE REWORK CHARGES TO BE DETERMINED BY PORTER INSTRUMENT DIVISION.

CERTIFICATE OF WARRANTY

THIS WARRANTY IS GIVEN IN PLACE OF ALL OTHER WARRANTIES, EXPRESS OR IMPLIED, OF MERCHANTABILITY, FITNESS FOR A PARTICULAR PURPOSE OR OTHERWISE.

Under no circumstances shall Parker Hannifin Corporation be liable for incidental or consequential damages as those terms are defined in the uniform commercial code.

Parker Hannifin Corporation, Porter Instrument Division warrants that each product or part shall be free from defects in workmanship and materials, under normal use and with appropriate maintenance, for one (1) year from the date of delivery to customer unless otherwise specified in writing. All rubber and plastic parts and accessories are warranted under the same conditions for a period of ninety (90) days from date of purchase.

No statement or claim about the product by any employee, agent, representative, or dealer of Parker Hannifin Corporation shall constitute a warranty by Parker Hannifin Corporation or give to rise to any liability or obligation of Parker Hannifin Corporation.

Parker Hannifin Corporation shall not be liable for any damage, injury or loss arising out of the use of the product, whether as a result of a defect in the product or otherwise, if, prior to such damage, injury or loss, the product was (1) damaged or misused; (2) repaired, altered or modified by persons other than Parker Hannifin Corporation; (3) not installed in strict compliance with applicable codes and ordinances; or (4) not installed by an authorized Parker Hannifin Corporation dealer. Parker Hannifin Corporation's obligation for breach of this warranty, or for negligence or otherwise, shall be strictly and exclusively limited to the repair or replacement of the product or part. This warranty shall be void on any product on which the serial number has been altered, defected or removed.

ORDERS All orders are to be made through authorized Parker Hannifin Corporation distributors. All billing will be done through said distributors. Direct orders will be handled through the authorized local dealer as determined by Parker Hannifin Corporation.

PRODUCTS

Automatic Vacuum Systems	10
Cabinet Mount Flowmeters	2,3,4
Emergency Oxygen/Resuscitation Systems	18
Flowmeters Systems	2 THRU 9
Flowmeter Mounts and Stands	16,17
Gas Supply Tubing	15
Manifold/Tank room Systems	
Sentinel	12
Vanguard	13
Manifold System Installation Kit (Nitrogen Test Fixture)	12
Nitrogen Equipment	19
Oral Surgery Flowmeter Systems	8
Outlet Stations	14
Porter Disposable Liners	9
Porter Navicom Communication System	21
Porter Scavenger Retrofit Kits	
for other manufacturer's Flowmeters	11
Porter Scavenger Systems	10
Porter Vacuum Control Kits	10
Pulse Oximeter	M-23
Steam Sterilizers and Water Treatment Systems	20
Zone Valves	12,13



Products Index
Flip catalog for Matrix Products



4465CAB-AV CABINET MOUNT MXR-DIGITAL FLOWMETER \$5,508.00

Flowmeter package w/(Universal Connections)
 Package includes: MXR-Digital flowmeter, AVS-5000 vacuum control, 5155-3 Breathing circuit, O2 & N2O shut-off valves, Bag tee mount and power supply for cabinet installations

4465CAB SAME AS ABOVE W/ (NO AVS-5000) \$5,165.00

Package includes: MXR-Digital flowmeter, 5155-1 Breathing Circuit, O2 & N2O shut-off valves, Bag tee mount and power supply for cabinet installations

4465WAL-AV WALL MOUNT MXR-Digital Flowmeter \$5,916.00

Flowmeter package w/ (Universal Connections)
 Package includes: MXR-Digital flowmeter, AVS-5000 vacuum control, 5155-3 Breathing circuit, O2 & N2O shut-off valves, Bag tee mount bezel and power supply for wall installations

4465WAL SAME AS ABOVE W/ (NO AVS-5000) \$5,573.00

Package includes: MXR-Digital flowmeter, 5155-1 Breathing Circuit, O2 & N2O shut-off valves, Bag tee mount bezel and power supply for wall installations

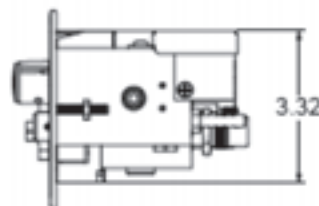
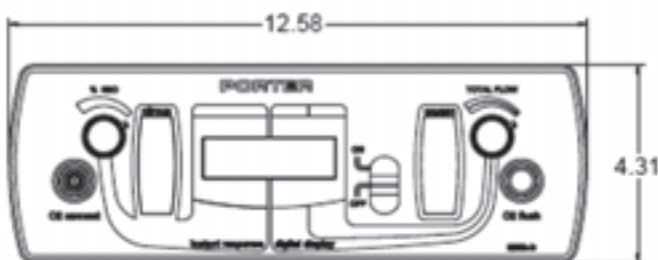
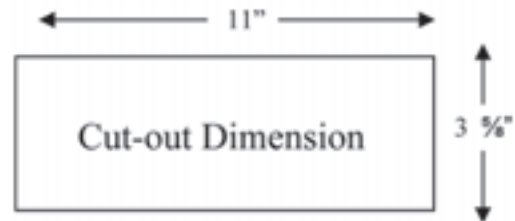
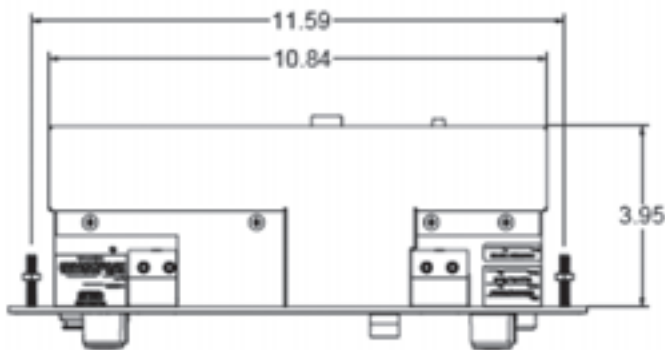



3465WF-AV MXR-1 FLUSHMOUNT FLOWMETER \$4,757.00

Flowmeter package w/(Universal Connections)
 Package includes: MXR-1 flowmeter, AVS-5000 vacuum control, 5155-3 Breathing circuit, O2 & N2O shut-off valves, Bag tee mount

3465WF SAME AS ABOVE W/ (NO AVS-5000) \$4,403.00

Package includes: MXR-1 flowmeter, 5155-1 Breathing circuit, O2 & N2O shut-off valves, Bag tee mount

*** Bezel for wall installations not included. Order seperately Bezel part number (B-2625) see page 23**

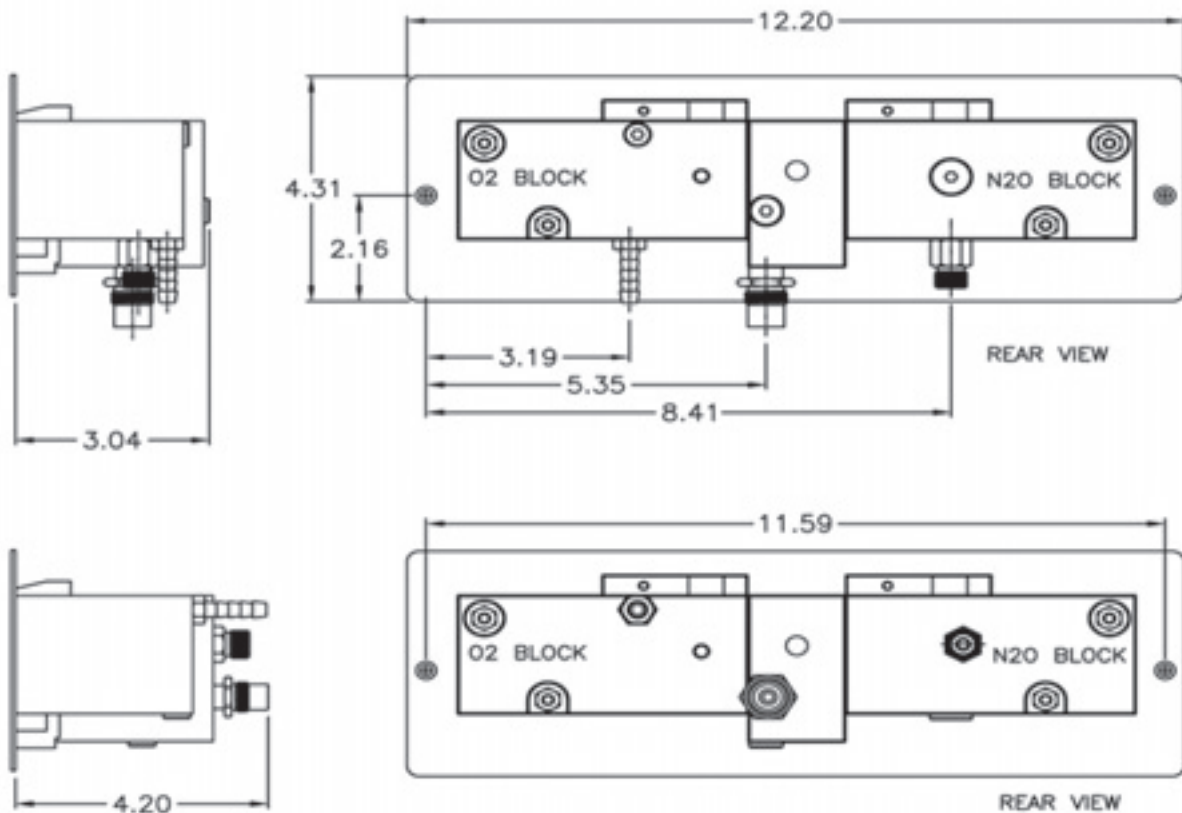
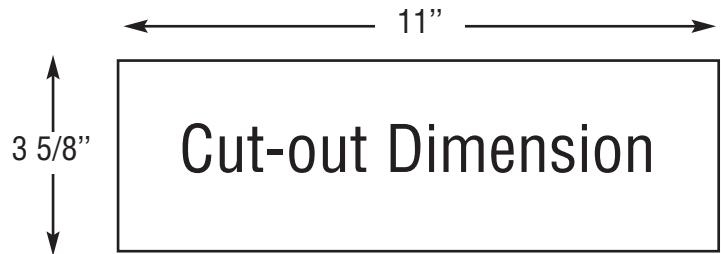

Flushmount Flowmeter Packages w/standard equipment



OR

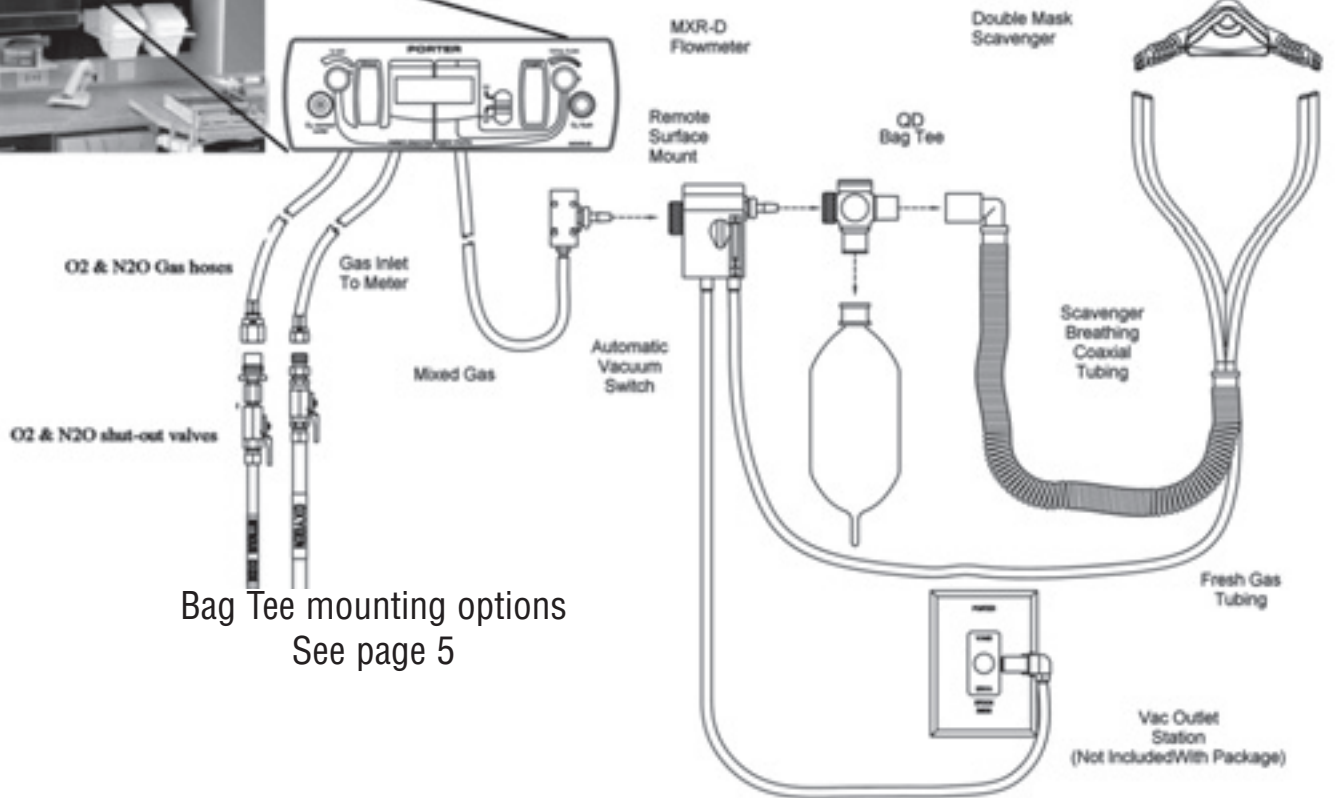

Bag Tee mounting options
See page 5

Bag Tee Mounting Options for Flushmount Flowmeters

A-1679 included with meter packages

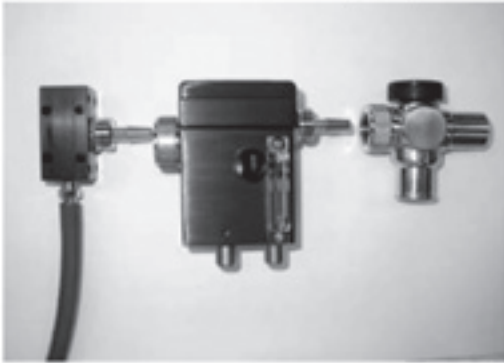

2037-1 under cabinet mount



2036-2 Left or Right side Slide mount with rubbergoods hook mounting option 5" wide



2036-4 Left or Right side Slide mount 3 1/2" wide for narrow installs



AVS-5000S Special 180 Swivel
Under cabinet or chair mount



P1407QD w/Quick Disconnect Option (T-Only)



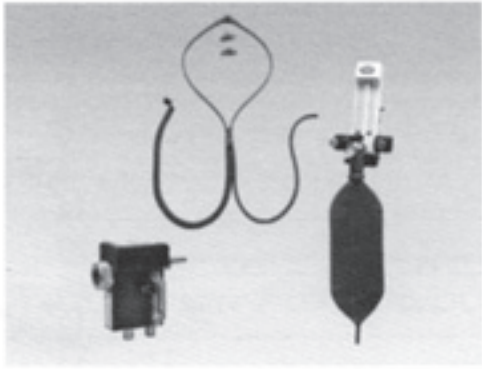

3400AV MXR-Flowmeter \$3,409.00
with Porter Scavenger Breathing Circuit
with New Automatic Vacuum Switch
 3000 MXR-Flowmeter
 4100-3NL Three Liter Bag (No-Latex)
 5155-3 Porter Scavenger Breathing Circuit
 AVS-5000 Automatic Vacuum Switch

3400 substitutes 5155-1 Breathing Circuit \$3,055.00
 See page 8 (no AVS)

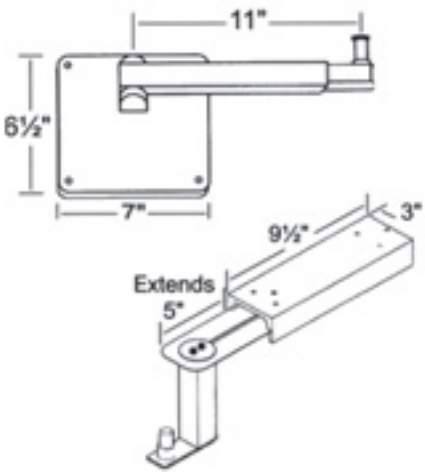

3420AV MXR Package (3400 AV) plus \$3,751.00
 2020 Solid Wall Mount
 Telescoping

3420 substitutes 5155-1 Breathing Circuit \$3,396.00
 See page 8 (no AVS)

3435-1AV MXR Package (3400 AV) plus \$3,784.00
 Cabinet Mount
 2035-1 Slide Away

3435-1 substitutes 5155-1 Breathing Circuit \$3,430.00
 See page 8 (no AVS)

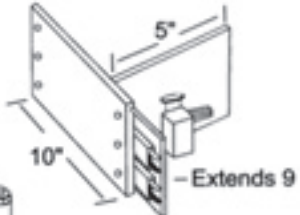

3436AV MXR Package (3400 AV) plus \$3,821.00
 2036-3 Cabinet Mount
 -Slide

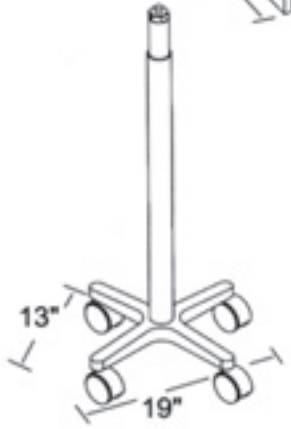

3436 substitutes 5155-1 Breathing Circuit \$3,470.00
 See Page 8 (no AVS)



3440AV MXR Package (3400 AV) plus \$3,840.00
 2040 Compact Mobile Stand

3440 substitutes 5155-1 Breathing Circuit \$3,486.00
 See page 8 (no AVS)

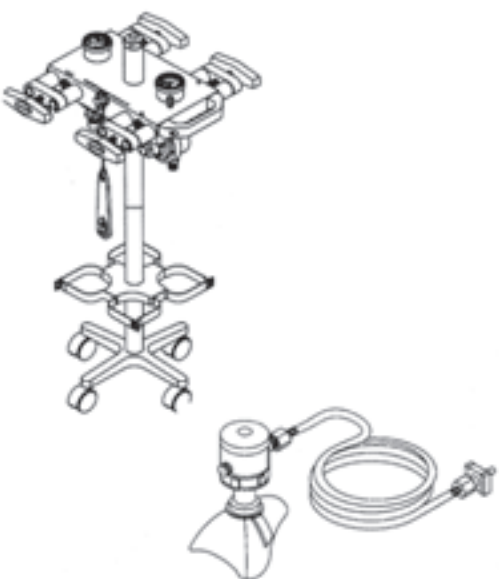
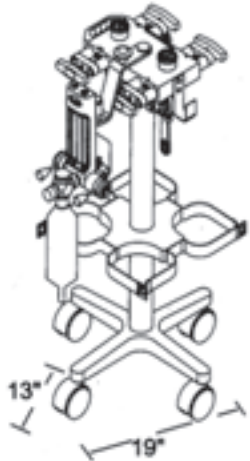
NOTE: When Scavenger is connected to a 6256-3 outlet with vacuum, order a 5602 found on page 15. Alternative vacuum packages can be found on page 10. Necessary Gas Supply Tubing can be found on page 15.

	<p>3445-2AV MXR Package (3400AV) plus \$5,745.00 2045-2 Tall Mobile Stand for 2+2 E Tanks (Top of meter telescopes from 43" to 50")</p>
	<p>3445-2 substitutes 5155-1 Breathing Circuit \$5,393.00 See page 8 (no AVS) (Top of meter telescopes from 43" to 50")</p>
	<p>3445E-2AV Same As Above plus \$6,361.00 1506-1 Positive Pressure/Demand Valve</p>
	<p>3445E-2 substitutes 5155-1 Breathing Circuit \$6,007.00 See page 8 (no AVS)</p>
	<p>3445-SAV MXR Package with under cabinet \$5,745.00 mobile stand for 2+2 "E" Tanks 31" to top of stand in storage position (Top of meter telescopes from 31" to 40")</p>
	<p>3445-S substitutes 5155-1 Breathing Circuit \$5,436.00 See page 8 (no AVS) 31" to top of stand in storage positions (Top of meter telescopes from 31" to 40")</p>
	<p>3445E-SAV Package with under cabinet \$6,404.00 Mobile stand for 2+2 "E" Tanks 31" to top of stand in storage position 1506-1 positive pressure/demand valve</p>
	<p>3445E-S substitutes 5155-1 Breathing Circuit \$6,051.00 See page 8 (no AVS) 31" to top of stand in storage position</p>

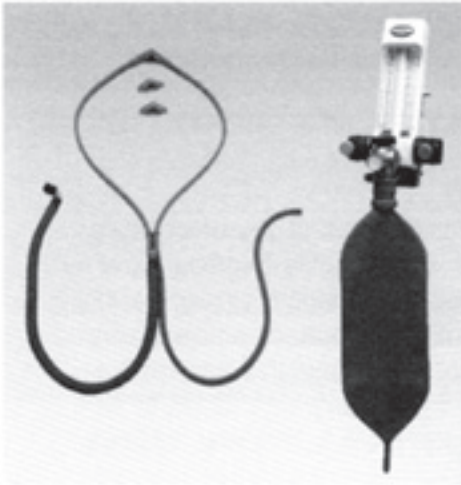

3400-OS Oral Surgery MXR-Flowmeter with Porter Scavenger Breathing Circuit \$3,142.00
 includes:
 3000-OS MXR Flowmeter (includes P2407A oral surgery threaded bag tee w/adapter)
 4100 Three Liter Bag
 5155-1 Porter Adult Inhaler Scavenger Assembly, complete
 Special Features:
 Higher Maximum flow rates
 Oral Surgery bag tee for 2210K Y valve



3444-OS Oral Surgery MXR-Flowmeter with Mobile Stand System \$4,527.00
 includes:
 3000-OS MXR flowmeter (includes P2407A oral surgery threaded bag tee w/adapter)
 4100 Three Liter Bag
 5155-1 Porter Adult Inhaler Scavenger Assembly, complete
 2210K Directional Y Valve
 1597 Non-rebreathing valve
 4200 Corrugate tube
 2044 Oral surgery Star-Base stand top of meter telescopes form 46" to 55"

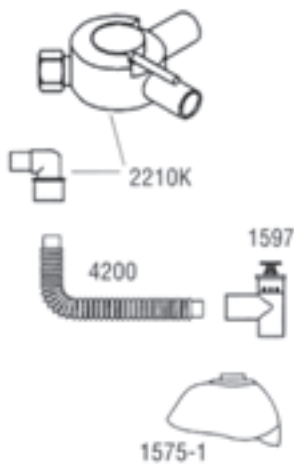

2200-OS Oral Surgery Accessory Package \$889.00
 includes:
 2210K Directional Y Valve
 1597 Non-rebreathing valve
 1575-1 Universal size full face, clear mask
 4200 Corrugated tube

Note: Must have threaded bag tee to attach 2210K Part # P2407A



B-5129-000 Flowmeter Rubbergoods Hook \$73.00
 For full face mask and corrugated tube

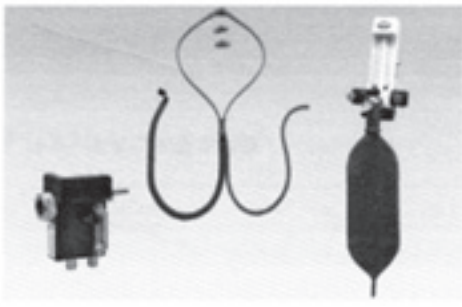

1400AV	Standard Flowmeter with Porter Scavenger Breathing Circuit (with Vacuum Control Block Kit)	\$3,282.00
1100	Standard Flowmeter	
4100	Three Liter Bag	
5155-3AV	Porter Adult Inhaler & Automatic Vacuum Switch	

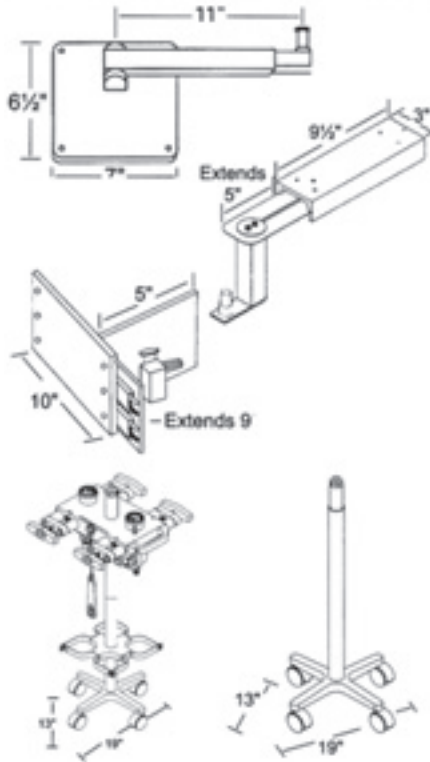

1420AV 2020	Same as above with Wall Mount	\$3,623.00
1435-1AV 2035-1	Same as above with Under Counter Slide Mount	\$3,659.00
1436AV 2036-3	Same as above with Slide Mount	\$3,698.00
1440AV 2040	Same as above with Mobile Stand	\$3,715.00
1445-2AV 2045-2	Same as above with Tall E Stand	\$5,619.00



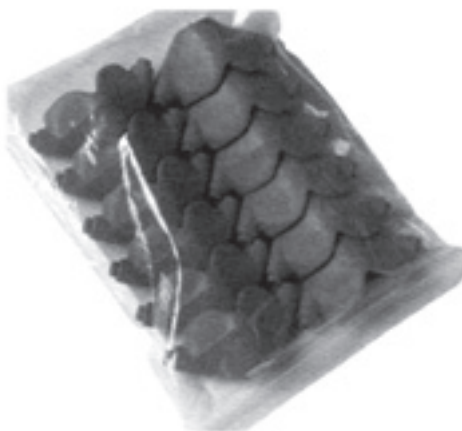

DISPOSABLE LINERS FOR PORTER SCAVENGER MASKS











THE MARKET LEADER IN SCAVENGING TECHNOLOGY		
5053 AD12	Porter Adult Disposable Liners	\$36.00
5053 AD12C	with Citrus Scent	\$36.00
One bag of (12) Adult Liners. Not Returnable		
5053 AD144	Porter Adult Disposable Liners	\$415.00
5053 AD144C	with Citrus Scent	\$415.00
One box of (12) bags. Each bag contains (12) Adult Liners Contents returnable when original box is unopened only.		
5053 PD12	Porter Pedo Disposable Liners	\$36.00
5053 PD12C	with Citrus Scent	\$36.00
One bag of Pedo Liners. Not Returnable		
5053 PD144	Porter Pedo Disposable Liners	\$415.00
5053 PD144C	with Citrus Scent	\$415.00
One box of (12) bags. Each bag contains (12) Pedo Liners Contents returnable when original box is unopened only.		

SCAVENGER SYSTEMS

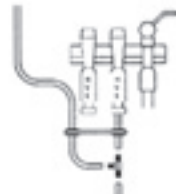
PORTER

	<p>AVS-5000 Automatic Vacuum Switch System \$435.00 Retrofits to ALL PORTER Manufactured Flowmeters (except 3000-0S)</p>
	<p>5155-3AV* Porter Adult Scavenger with Automatic Vacuum Switch \$945.00 5155-4AV* Porter Pedo Scavenger with Automatic Vacuum Switch \$945.00</p>
	<p>5155-1* Porter Adult Scavenger Breathing Circuit with In-Line Vacuum Control Kit \$644.00 5155-2* Porter Pedo Scavenger Breathing Circuit with In-Line Vacuum Control Kit \$644.00 5155-3* Porter Adult Scavenger Breathing Circuit (no Vacuum Control Block) \$542.00 5155-4* Porter Pedo Scavenger Breathing Circuit (no Vacuum Control Block) \$542.00</p> <p>* Note: Packages do NOT include 5602 Vac Quick Conn or 4100 Bag. Please order separately.</p>
	<p>5054A Porter Adult Hood Kit - w/3 liners \$254.00 5054B Porter Pedo Hood Kit - w/3 liners \$254.00 5054-1 Porter Adult Liner Kit - pkg of 3 \$51.00 5054-2 Porter Pedo Liner Kit - pkg of 3 \$51.00</p>

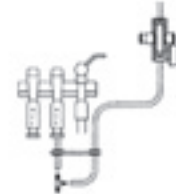
OPTIONS FOR VACUUM HOOK-UP

 <p>Part No. AVS-5000 Automatic Vacuum Switch</p>	 <p>High Volume Evacuation (HVE) Attachment</p>  <p>Tee Connection in the Vacuum Line</p>  <p>PVC Vacuum Line Hook-Up</p>
 <p>Part No. 5501 RK Vacuum Control Block</p>	 <p>High Volume Evacuation (HVE) Attachment</p>  <p>Tee Connection in the Vacuum Line</p>  <p>PVC Vacuum Line Hook-Up</p>

RETROFIT KITS

PORTER



All kits include the Porter Scavenger with In-Line Vacuum (specify "A" for Adult Hood or "P" for Pedo Hood), Three Liter Breathing Bag, Flowmeter Adapters and Bag Tee where necessary.

5800-1A (Adult) \$684.00

5800-1P (Pedo) \$684.00

This one kit retrofits all these flowmeters:

- Matrix - Quantiflex, MDM
- Ohmeda
- Fraser Harlake
- Fraser Sweatman
- MDT-McKesson - Anolor Four/Compalor
- Parkell-Sedatron (*not pictured*)
- Belmed
- Accutron (*not pictured*)

Also Replaces: Porter Clean-Air™ Rubber Goods Non-Scavenging System



5800-2A Coastal \$775.00
NCG Chemetron



5800-4A Hampton \$788.00
Simplaire Micro



5800-5A McKesson \$735.00
Anolor I&II
Starflite Denetron



5800-6A McKesson \$788.00
Anolor 3C



5800-9A Porter Clean-Air™ \$627.00
Breathing Circuit & Canister
Scavenging System



Note: *It is not recommended to retrofit Porter Scavenger Breathing Circuit to Adec, Veriflo or Spica machines.*



For 2 Tanks Oxygen and 2 Tanks Nitrous Oxide

3222CX Manifold System, 2-O₂, N₂O, \$3,874.00
with wall model sentinel, regulators hoses, and tank restraints

3222DX Manifold System, 2-O₂, N₂O, \$3,874.00
with desk model sentinel, regulators hoses, and tank restraints

For 2 Tanks Oxygen and 1 Tanks Nitrous Oxide

3221CX Manifold System, 2-O₂, 1-N₂O, \$3,568.00
with wall model sentinel, regulators, hoses, and tank restraints

3221DX Manifold System, 2-O₂, 1-N₂O, \$3,568.00
with desk model sentinel, regulators, hoses, and tank restraints



3222CX-N/R&H Manifold System \$2,658.00
with wall sentinel;
WITHOUT regulators and hoses

3222DX-N/R&H Manifold System \$2,658.00
with desk sentinel;
WITHOUT regulators and hoses

3222MXB Sentinel Manifold ONLY \$1,974.00
5251 **Wall Sentinel** \$762.00
(includes 75' cable & power supply)
5201 **Desk Sentinel** \$762.00
(includes 75' cable & power supply)

Manifolds without Sentinel DO NOT meet the requirements of the NFPA 99. Porter Instrument Division accepts no responsibility for the installation and/or use of manifolds without Sentinel alarm.

ZONE VALVES WITH CROSS+PROTECTION



9000-1 Concealed Zone Valve \$1,206.00
For use with 3222MXB Sentinel Manifold

Note: NFPA 99-GAS SHUT-OFF VALVES Where the central supply is remote from the medical gas system use points, the main supply line shall be provided with a shut-off valve (Zone Valve) is located in the single treatment facility as to be accessible from use-point locations in an emergency.

MANIFOLD INSTALLATION KIT



B-2065-000 Nitrogen Test Fixture \$735.00
(includes adapter hoses)

VANGUARD MANIFOLD SYSTEMS WITH AUTOMATIC CHANGEOVER PORTER



4222CXB (high flow) Vanguard Manifold Systems \$4,949.00
with Auto-changeover for 2 N2O
& 2 O2 tanks, Wall alarm, regulators
hoses and restraints

4222DXB (high flow) Vanguard Manifold Systems \$4,949.00
with 6201 A Desk style Alarm

4222CXBLPI (high flow) Vanguard Manifold Systems \$4,721.00
Wall Alarm **WITHOUT** Pre-Install Kit

4222DXBLPI (high flow) Vanguard Manifold Systems \$4,721.00
Desk Alarm **WITHOUT** Pre-Install Kit

4222NOHF-1 (high flow) Vanguard Manifold Only \$3,541.00

6251A Vanguard Wall Alarm Only \$1,193.00

6201A Vanguard Desk Alarm Only \$1,193.00





3653-EZW Manifold Pre-Install Kit \$602.00
Note: order "LPI" Packages
to complete systems.

ZONE VALVES WITH CROSS + PROTECTION









9000-2 Concealed Zone Valve \$1,206.00
For use with 4222 Vanguard Manifold

Note: NFPA 99-GAS SHUT-OFF VALVES Where the central supply is remote from the medical gas system use points, the main supply line shall be provided with a shut-off valve (Zone Valve) is located in the single treatment facility as to be accessible from use-point locations in an emergency.

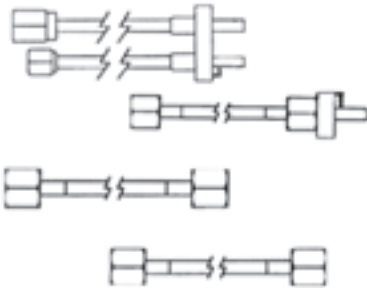

	<p>6100-1 Single Oxygen Outlet Station Requires Hose, O₂, diss/Porter listed on page 13</p>	<p>\$282.00</p>
	<p>6200-1 Dual Outlet Station, O₂/N₂O</p>	<p>\$360.00</p>
	<p>6250K Exposed Cover for 6100-1/6200-1</p>	<p>\$43.00</p>
	<p>6300-1 Floor Mounted Outlet Station</p>	<p>\$607.00</p>
	<p>6256-3 Triple Outlet O₂/N₂O/Vacuum</p>	<p>\$565.00</p>
	<p>6257-3 Exposed Triple Outlet O₂/N₂O/Vacuum</p>	<p>\$595.00</p>
	<p>6255-1 Compact Wall Triple Outlet O₂/N₂O/Vacuum</p>	<p>\$565.00</p>
	<p>6258-1 Compact Triple Outlet for Cabinets (no hoses or shutoffs)</p>	<p>\$565.00</p>
	<p>6258-3 Compact Triple Outlet for Cabinets with 3 foot hoses and shutoffs</p>	<p>\$979.00</p>
	<p>6258-5 Compact Triple Outlet for Cabinets with 5 foot hoses and shutoffs</p>	<p>\$979.00</p>
	<p>6258-1B Compact triple outlet w/back connection for Cabinets (no hoses or shutoffs)</p>	<p>\$565.00</p>
	<p>6258-3B Compact triple outlet w/back connection with 3 foot hoses and shutoffs</p>	<p>\$979.00</p>
	<p>6258-5B Compact triple outlet w/back connection with 5 foot hoses and shutoffs</p>	<p>\$979.00</p>
	<p>5600-3 Vacuum Outlet Station</p>	<p>\$323.00</p>

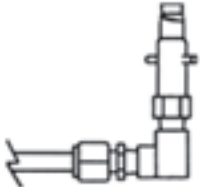
GAS SUPPLY TUBING CROSS + PROTECTION

PORTER

	<p>8065 Hose, O₂/N₂O, diss/Porter, 5ft. \$226.00</p> <p>8055* Hose, O₂, diss/Porter, 5ft. \$182.00</p> <p>8005* Hose, O₂, diss/diss, 5ft. \$121.00</p> <p>8505* Hose, N₂O, diss/diss, 5ft. \$121.00</p>
	<p>8015* Hose, O₂, diss/NCG (Chemetron), 5ft. \$196.00</p> <p>8515* Hose, N₂O, diss/NCG (Chemetron), 5ft. \$196.00</p>
	<p>8025* Hose, O₂, diss/Puritan, 5ft. \$196.00</p> <p>8525* Hose, N₂O, diss/Puritan, 5ft. \$196.00 for use with McKesson & Fraser Harlake outlet stations</p>
	<p>8035* Hose, O₂, diss/Schrader, 5ft. \$218.00</p> <p>8535* Hose, N₂O, diss/Schrader, 5ft. \$218.00</p>
	<p>8045* Hose, O₂, diss/Oxequip, 5ft. \$196.00</p> <p>8545* Hose, N₂O, diss/Oxequip, 5ft. \$196.00</p>
	<p>92305126-5* Hose, O₂, diss/Ohio Medical/Matrix, 5 ft. \$203.00</p> <p>92305127-5* Hose, N₂O, diss/Ohio Medical/Matrix, 5 ft. \$203.00</p>
<p>Note Hose Sizes</p>	<p>*ALL STOCK NUMBERS LISTED ABOVE ARE FOR A 5 FOOT HOSE ASSEMBLY. Last digit indicates length in feet. Example: 8053 Hose, O₂, diss/Porter - 3 feet long.</p> <p>Note: Hoses longer than 5 feet are custom made. Add \$6.00 per foot ALL SALES ARE FINAL</p>
	<p>5602 Vacuum Quick Connect for Porter outlets \$107.00</p> <p>5670 Vacuum Quick Connect for Matrix outlets \$107.00</p>

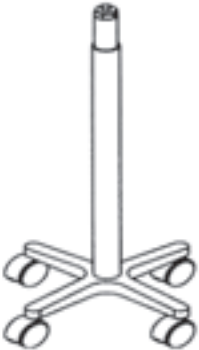
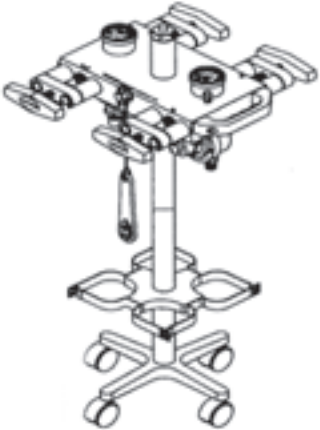
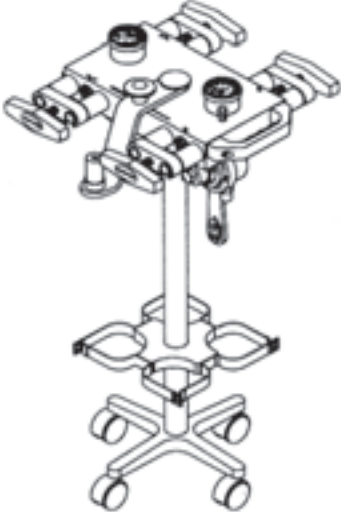
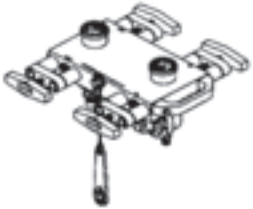
	<p>2020 Solid Wall Mount (Telescoping) Extends to 18"</p>	<p>\$368.00</p>
	<p>2035-1 Cabinet Mount, Slide Away</p>	<p>\$408.00</p>
	<p>2036-2 Cabinet Slide Mount For Bag Tee and Porter AVS-5000 (5" wide)</p>	<p>\$430.00</p>
<p>2036-3 Cabinet Slide Mount For Flowmeter</p>	<p>\$442.00</p>	
<p>2036-4 Cabinet Slide Mount For Bag Tee and Porter AVS-5000 (3" wide)</p>	<p>\$430.00</p>	
<p>2037-1 Under Cabinet Slide Mount For Bag Tee and Porter AVS-5000</p>	<p>\$430.00</p>	
	<p>5335 Chair/Light Post Mount (BagTee or AVS)</p>	<p>\$247.00</p>
	<p>2024 Post Clamp for Meters</p>	<p>\$366.00</p>
<p>2023 Non-Telescoping Wall Bracket</p>	<p>\$182.00</p>	

	<p>2040 Compact Mobile Stand \$442.00 (Top of Meter Telescopes from 24" to 36")</p> <p>2042 Tall Mobile Stand \$452.00 (Top of Meter Telescopes from 43" to 50")</p>
	<p>2045-2 Tall Mobile Stand \$2516.00 for 2 "E" Tanks of O2 and 2 "E" Tanks of N2O (Top of meter telescopes from 43" to 50") <i>Gas Supply Tubing included</i></p>
	<p>2045-Short Under Cabinet Stand \$2633.00 for 2 "E" Tanks of O2 and 2 "E" Tanks fo N2O (Top of meter telescopes from 31" to 41") <i>Gas Supply Tubing included</i></p>
	<p>C-349-2 E-Block Assembly \$2101.00</p>
	<p>A-3492-000 Tank Restraints \$94.00</p>

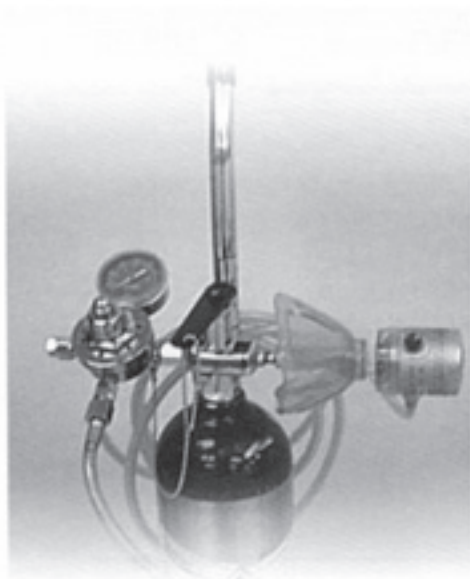

1536-1 Positive Pressure/Demand Valve \$1071.00
with Universal Mask; 10 foot Hose; Mobile
Cart; Regulator and Yoke; and Porter Connection

The Porter/O-TWO Demand Valve Resuscitator provides a fast, simple and effective means to ventilate non-breathing patients and provides 100% oxygen on Demand.

Designed to meet the varying requirements of the Emergency Medical Services/Rescue Personnel, it is the only Demand Valve Resuscitator that comes standard with an Audible Pressure Relief System and sensitive Manual Ventilation Button, conveniently located on the front of the resuscitator. The Manual Ventilation Button helps to ensure a patient airway by enabling both hands to remain on the mask to facilitate a superior mask to face seal (without having to deal with cumbersome trigger levers or inconveniently located top buttons).

The Manual Ventilation Flow rate is fixed at 40 lpm in line with the 1992 American Heart Association Recommendations and Guidelines for Resuscitation.

During spontaneous respirations, the Demand Valve Resuscitator is designed to provide 100% oxygen to a breathing patient with minimal respiratory effort. The oxygen demand flow is controlled by the patients inspiratory effort, with flow rates up to 160 lpm, to accommodate their own respiratory distress situation.

1538 Mobile Cart Only \$174.00
(Tank not included)

1506-1 Positive Pressure/Demand Valve \$623.00
with Universal Mask, 10 foot hose
and Porter Connection

1506-1M Positive Pressure/Demand Valve \$623.00
with Universal Mask, 10 foot hose
and Ohio Medical (Matrx) Connection

Components on Page 31

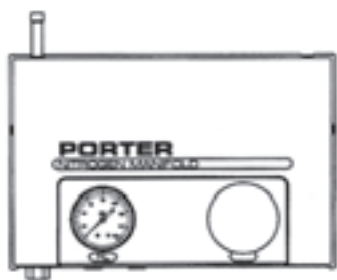

8201 Nitrogen Manifold System \$1,918.00
Includes one regulator & one 3ft. hose

8202 Nitrogen Manifold System \$2,453.00
Includes two regulators & two 3ft. hoses

8203 Nitrogen Manifold System \$2,987.00
Includes three regulators & three 3ft. hose



6400-1 Nitrogen Outlet Station \$532.00
Nitrogen DISS Fitting w/Check Valve

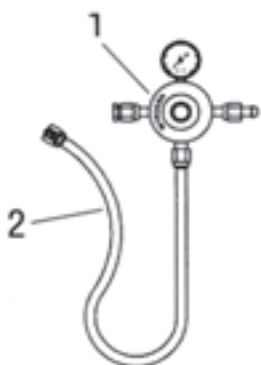

PARTS ONLY

1.7400-1 Nitrogen Regulator Only \$418.00

2. 8803 Nitrogen Hose, diss/diss, 3ft. \$120.00
Note: Stock number listed is for 3 ft. Last digit indicates length.
Example: 8805 hose N₂,
diss/diss=5ft. long

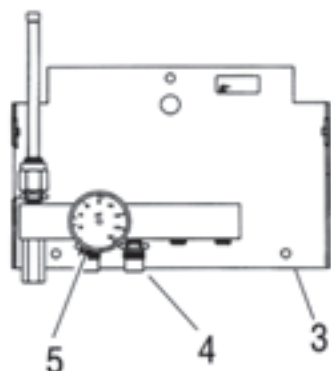

3. 8200 Nitrogen Manifold Only \$1,449.00

4. PA-1140-000 Nitrogen Check Valve Assy. \$84.00

5. PA-1143-000 Nitrogen Gauge \$65.00

**PORTER NAVICOM®
COMMUNICATION SYSTEM**

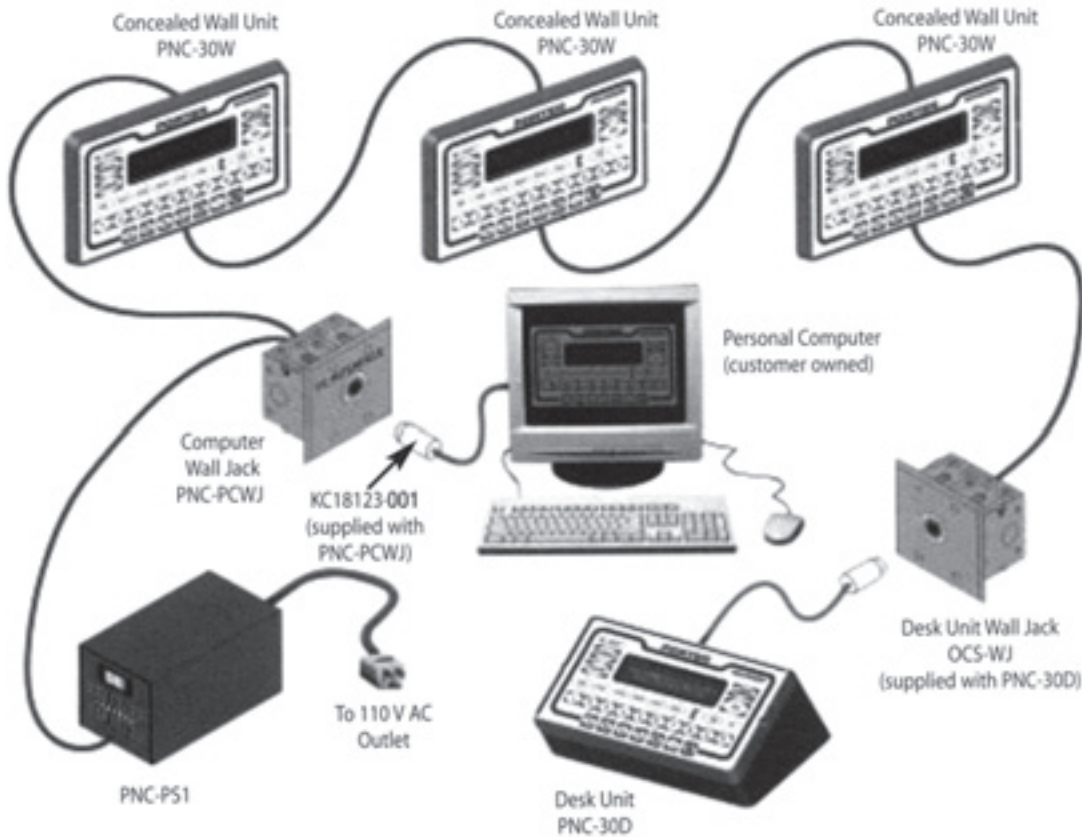

PNC-30W	Navicom Wall Station	\$848.00
PNC-30D	Navicom Desk Station	\$927.00
PNC-PCWJ	Computer Wall Jack Kit w/cd software	\$555.00
PNC-PS1	Power Supply	\$780.00
PV-100	Round Cable w/PVC Jacket (100 feet)	\$214.00
PV-250	Round Cable w/PVC Jacket (250 feet)	\$525.00
TF-100	Round Cable w/Teflon Jacket (100 feet)	\$437.00
TF-250	Round Cable w/Teflon Jacket (250 feet)	\$1054.00

NEW!



PORTER ReliANT Sterilier System

RELIANT-2510

\$5,400.00

The Porter Reliant sterilizer system is equipped with a powerful drying pump which combined with the bacterial filter, provides an end-of-cycle forced ventilation, resulting in complete drying of loose or wrapped loads

ADVANCED FEATURES: PERFORMANCE YOU CAN COUNT ON

Automated microprocessor cycles off to save energy Copper components in chamber for precise temperature control, Complete air-evacuation (up to 98%) ensures proper steam saturation, prevents air pockets, and assures complete sterilization

PURITY OR2 WATER TREATMENT SYSTEM

10026400

\$1,209.00

The Porter Purity - Integrated Reverse Osmosis Water Purifier



PORTER